

# NUF6005MU

## 6 Line EMI Filter with ESD Protection in UDFN Package

This device is a 6 line EMI filter array for wireless applications. Greater than -25 dB typical attenuation is obtained at frequencies from 800 MHz to 3.0 GHz. The NUF6005MU has a typical cut-off frequency of 185 MHz. This UDFN package is specifically designed to enhance EMI filtering for low-profile or slim design electronics especially where space and height is a premium. It also offers ESD protection clamping transients from static discharges. ESD protection is provided across all capacitors.

### Features

- EMI Filtering and ESD Protection
- Integration of 30 Discrete Components
- UDFN Package, 1.2 x 2.5 mm
- Moisture Sensitivity Level 1
- ESD Ratings: IEC61000-4-2 (Level 4)  
Machine Model = C  
Human Body Model = 3B
- This is a Pb-Free Device\*

### Benefits

- Reduces EMI/RFI Emissions on a Data Line
- Low Profile Package; Typical Height of 0.5 mm
- Design-Friendly and Easy-to-Use Pin Configurations, Particularly for Portable Electronics
- Integrated Solution Offers Cost and Space Savings in UDFN Package
- Excellent S21 Characteristics with very Low Parasitic Inductances
- Integrated Solution Improves System Reliability

### Applications

- EMI Filtering and ESD Protection for Data Lines
- Keypad Interface and Protection for Portable Electronics
- Bottom Connector Interface for Mobile Handsets
- Notebook Computers and Digital Cameras
- LCD Display Interface in Mobile Handsets
- Camera Display Interface in Mobile Handsets

\*For additional information on our Pb-Free strategy and soldering details, please download the ON Semiconductor Soldering and Mounting Techniques Reference Manual, SOLDERRM/D.



ON Semiconductor®

<http://onsemi.com>

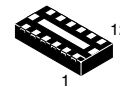
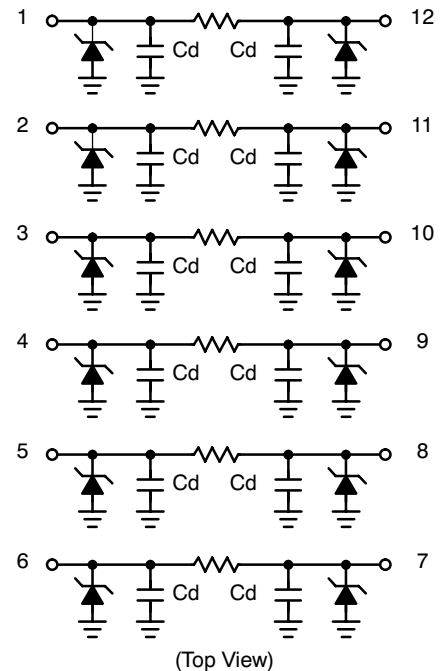

UDFN12  
MU SUFFIX  
CASE 517AE

### MARKING DIAGRAM



- 605 = Specific Device Code
- M = Date and Assembly Location
- = Pb-Free Package

### ORDERING INFORMATION

Device	Package	Shipping†
NUF6005MUT2G	UDFN12 (Pb-Free)	3000 / Tape & Reel

†For information on tape and reel specifications, including part orientation and tape sizes, please refer to our Tape and Reel Packaging Specifications Brochure, BRD8011/D.

# NUF6005MU

## MAXIMUM RATINGS (T<sub>J</sub> = 25°C unless otherwise noted)

Parameter	Symbol	Value	Unit
ESD Discharge IEC61000-4-2 Contact Discharge	V <sub>PP</sub>	8	kV
DC Power per Resistor	P <sub>R</sub>	100	mW
DC Power per Package	P <sub>T</sub>	600	mW
Operating Temperature Range	T <sub>OP</sub>	-40 to 85	°C
Storage Temperature Range	T <sub>STG</sub>	-55 to 150	°C
Maximum Lead Temperature for Soldering Purposes (1.8 in from case for 10 seconds)	T <sub>L</sub>	260	°C

Stresses exceeding Maximum Ratings may damage the device. Maximum Ratings are stress ratings only. Functional operation above the Recommended Operating Conditions is not implied. Extended exposure to stresses above the Recommended Operating Conditions may affect device reliability.

## ELECTRICAL CHARACTERISTICS (T<sub>J</sub> = 25°C unless otherwise noted)

Parameter	Symbol	Test Conditions	Min	Typ	Max	Unit
Maximum Reverse Working Voltage	V <sub>RWM</sub>				5.0	V
Breakdown Voltage	V <sub>BR</sub>	I <sub>R</sub> = 1.0 mA	6.0	7.0	8.0	V
Leakage Current	I <sub>R</sub>	V <sub>RWM</sub> = 3.3 V		10	100	nA
Resistance	R <sub>A</sub>	I <sub>R</sub> = 20 mA	85	100	115	Ω
Capacitance (Notes 1 and 2)	C <sub>d</sub>	V <sub>R</sub> = 2.5 V, f = 1.0 MHz		10	15	pF
Cut-Off Frequency (Note 3)	f <sub>3dB</sub>	Above this frequency, appreciable attenuation occurs		185		MHz

1. Measured at 25°C, V<sub>R</sub> = 2.5 V, f = 1.0 MHz.
2. Total line capacitance is 2 times the Diode Capacitance (C<sub>d</sub>).
3. 50 Ω source and 50 Ω load termination.

# NUF6005MU

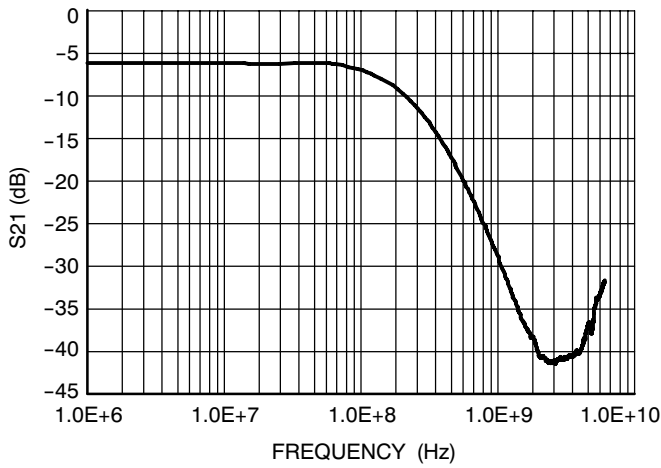

**Figure 1. Typical Insertion Loss**

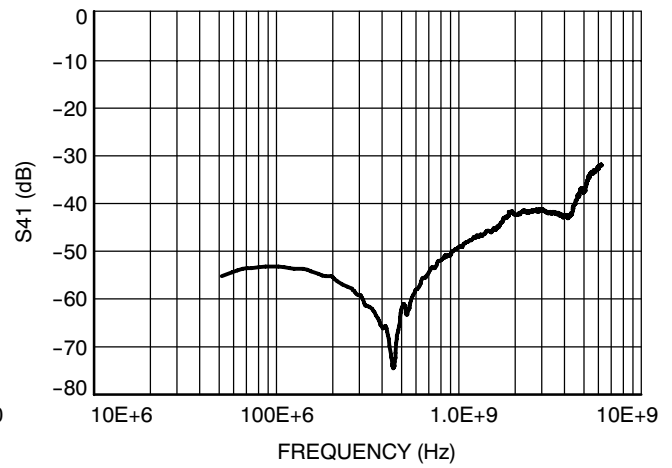

**Figure 2. Typical Analog Crosstalk**

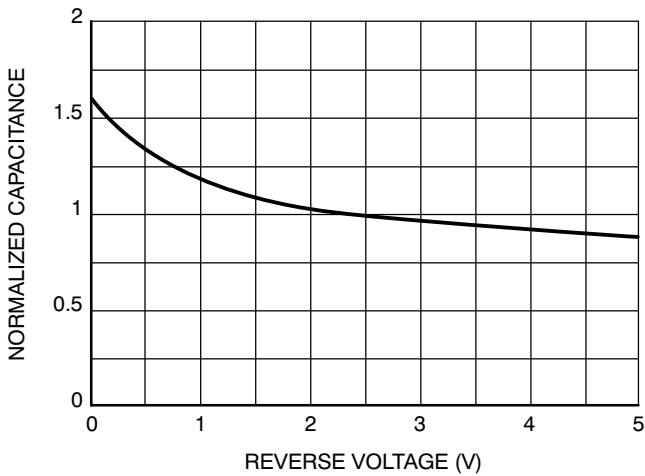

**Figure 3. Typical Capacitance vs. Reverse Biased Voltage (Normalized Capacitance, Cd @ 2.5 V)**

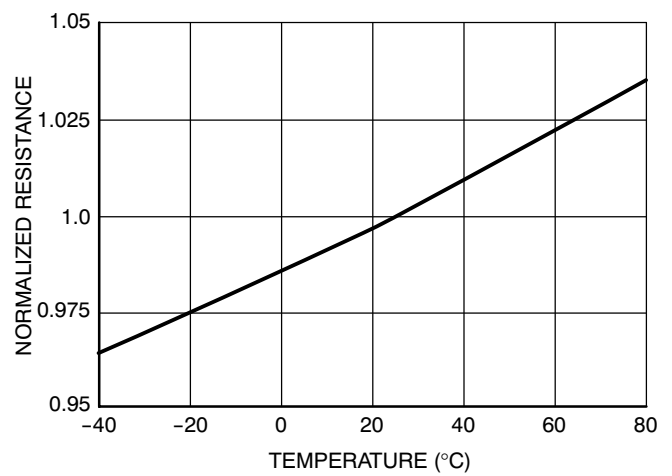
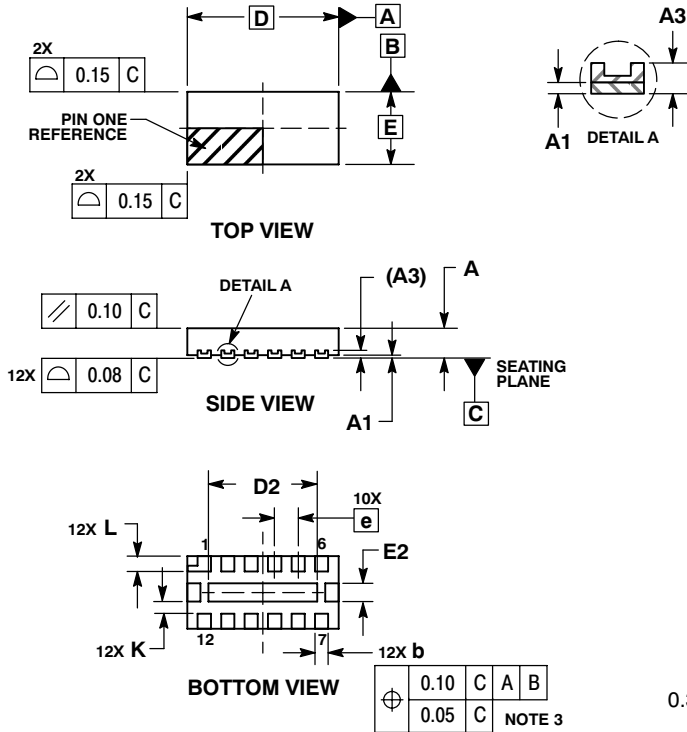

**Figure 4. Typical Resistance over Temperature (Normalized)**

# NUF6005MU

## PACKAGE DIMENSIONS

UDFN12, 2.5x1.2, 0.4P  
CASE 517AE-01  
ISSUE O



**NOTES:**

1. DIMENSIONING AND TOLERANCING PER ASME Y14.5M, 1994.
2. CONTROLLING DIMENSION: MILLIMETERS.
3. DIMENSION b APPLIES TO PLATED TERMINAL AND IS MEASURED BETWEEN 0.25 AND 0.30 mm FROM TERMINAL.
4. COPLANARITY APPLIES TO THE EXPOSED PAD AS WELL AS THE TERMINALS.

MILLIMETERS			
DIM	MIN	NOM	MAX
A	0.45	0.50	0.55
A1	0.00	0.03	0.05
A3	0.127 REF		
b	0.15	0.20	0.25
D	2.50 BSC		
D2	1.70	1.80	1.90
E	1.20 BSC		
E2	0.20	0.30	0.40
e	0.40 BSC		
K	0.20	---	---
L	0.20	0.25	0.30

### SOLDERING FOOTPRINT\*

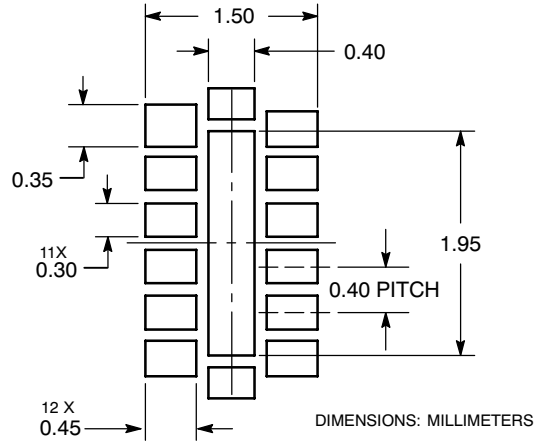

\*For additional information on our Pb-Free strategy and soldering details, please download the ON Semiconductor Soldering and Mounting Techniques Reference Manual, SOLDERRM/D.

ON Semiconductor and are registered trademarks of Semiconductor Components Industries, LLC (SCILLC). SCILLC reserves the right to make changes without further notice to any products herein. SCILLC makes no warranty, representation or guarantee regarding the suitability of its products for any particular purpose, nor does SCILLC assume any liability arising out of the application or use of any product or circuit, and specifically disclaims any and all liability, including without limitation special, consequential or incidental damages. "Typical" parameters which may be provided in SCILLC data sheets and/or specifications can and do vary in different applications and actual performance may vary over time. All operating parameters, including "Typicals" must be validated for each customer application by customer's technical experts. SCILLC does not convey any license under its patent rights nor the rights of others. SCILLC products are not designed, intended, or authorized for use as components in systems intended for surgical implant into the body, or other applications intended to support or sustain life, or for any other application in which the failure of the SCILLC product could create a situation where personal injury or death may occur. Should Buyer purchase or use SCILLC products for any such unintended or unauthorized application, Buyer shall indemnify and hold SCILLC and its officers, employees, subsidiaries, affiliates, and distributors harmless against all claims, costs, damages, and expenses, and reasonable attorney fees arising out of, directly or indirectly, any claim of personal injury or death associated with such unintended or unauthorized use, even if such claim alleges that SCILLC was negligent regarding the design or manufacture of the part. SCILLC is an Equal Opportunity/Affirmative Action Employer. This literature is subject to all applicable copyright laws and is not for resale in any manner.

### PUBLICATION ORDERING INFORMATION

**LITERATURE FULFILLMENT:**  
Literature Distribution Center for ON Semiconductor  
P.O. Box 5163, Denver, Colorado 80217 USA  
Phone: 303-675-2175 or 800-344-3860 Toll Free USA/Canada  
Fax: 303-675-2176 or 800-344-3867 Toll Free USA/Canada  
Email: orderlit@onsemi.com

**N. American Technical Support:** 800-282-9855 Toll Free  
USA/Canada  
**Europe, Middle East and Africa Technical Support:**  
Phone: 421 33 790 2910  
**Japan Customer Focus Center**  
Phone: 81-3-5773-3850

**ON Semiconductor Website:** [www.onsemi.com](http://www.onsemi.com)  
**Order Literature:** <http://www.onsemi.com/orderlit>  
For additional information, please contact your local Sales Representative